

**Artize**

KAS-WHT-49931

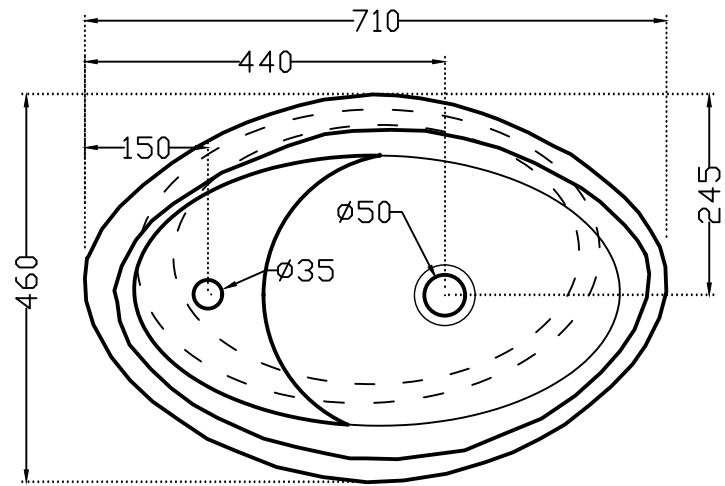

TOP VIEW

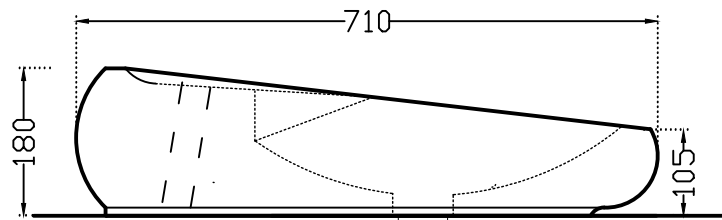

FRONT VIEW

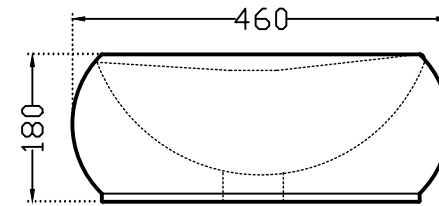

SIDE VIEW

ALL DIMENSIONS ARE IN MM.  
(TOLERANCE  $\pm 5$  MM)